

AM/SSB CB Transceiver

TRC-449



OWNER'S MANUAL

PLEASE READ BEFORE
USING THIS EQUIPMENT

REALISTIC[®]

**CAT. NO.
21-9449**

CUSTOM MANUFACTURED FOR TANDY CORPORATION

Your REALISTIC TRC-449 is a completely solid-state AM/SSB Transceiver for 27 MHz Citizens Band use. It uses a frequency synthesizing circuit with Digital Phase Locked Loop techniques to provide crystal-controlled transmit and receive operation on all 18 channels. The PLL circuitry assures ultra-precise frequency control. You can use your TRC-449 Transceiver on any one of the channels in the conventional AM mode, plus the same 18 channels in either the Upper Single Sideband mode or the Lower Single Sideband mode.

This flexibility not only doubles the effective number of channels from 18 to 54, but SSB also increases the effective range of communication because all the power is concentrated in one sideband to provide 100% talk-power. Single Sideband reception also adds advantages in sensitivity and selectivity, plus lower signal-to-noise. This of course also contributes to an increase in operating range.

The TRC-449 has been carefully designed for ease of operation. You can select AM, Upper Sideband or Lower Sideband with the simple change of a 3-position switch. Transmission is simple too—just press the microphone button. Ordinarily an SSB signal will reach further and be heard more clearly than an equivalent AM signal. SSB reception is simple—just adjust the CLARIFIER control to bring in the voice transmissions.

We've added all the other most wanted features for optimum communications – RF Gain control, Squelch, Clarifier, PA, Dimmer, Meter and Noise Blanker circuits.

The TRC-449 is designed to operate from 12 volt DC negative or positive ground electrical systems.

For your own protection, we urge you to record the Serial Number of this unit in the space provided. You'll find the Serial Number on the back panel of the unit.

Serial Number

SPECIFICATIONS

GENERAL:

Channels	: 18 Channels for AM, Upper Side Band and Lower Side Band, utilizing Digital Circuitry
Frequency Range	: 27.015 MHz to 27.225 MHz
Frequency Control	: Digital (Phase Lock Loop) Synthesizer
Frequency Accuracy	: ± 100 Hz
Operating Temperature Range	: -20° C to +50° C
Power Requirements	: 13.8V DC (12-16 volts DC, negative or positive ground)
Antenna	: 52 ohm (Coaxial connector)
Microphone	: 600 ohm Dynamic Type
Speaker	: 8 ohm, 3 Watt
Size	: 6 x 20 x 26.6 cm (HWD)
Weight	: 2.65 kg
Accessories	: DC Cord with in-line Fuse, Microphone and Microphone Hanger and Mounting Brackets

RECEIVER:

Max. Sensitivity	: AM — 0.5 μ V SSB — 0.25 μ V
Sensitivity for 10 dB S/N	: AM — 0.5 μ V or better SSB — 0.25 μ V or better
AGC Figure of Merit 50 mV for 10 dB Change in Audio output	: AM — 90 dB SSB — 90 dB
Overload AGC Characteristics from 10 mV to 100 mV	: AM — \pm 3 dB SSB — \pm 3 dB
Overall Audio Fidelity at 6 dB Down Upper Frequency	: AM — 2100 Hz SSB — 3500 Hz
Lower Frequency	: AM — 450 Hz SSB — 450 Hz
Adjacent Channel Selectivity	: AM — 65 dB SSB — 65 dB
Image Rejection (42.6 MHz)	: Typically better than 80 dB
IF Rejection	: 85 dB or better
Maximum Audio Output Power	: 4 Watts
Squelch Range	: AM — Adjustable from 0.5 μ V to 1 mV SSB — Adjustable from 0.25 μ V to 1 mV
Battery Drain at no Signal	: Less than 1,000 mA
Battery Drain at Max. Output Power	: Less than 2,000 mA
Receiver Clarifier Range	: \pm 1.25 kHz, variable

TRANSMITTER:

Max. Output Power	: AM — 4 Watts SSB — 12 Watts PEP
Spurious Emission	: — 60 dB or better
Battery Drain	: At no Modulation — AM/Less than 2,600 mA SSB/Less than 1,500 mA At Max. Output Power — AM/Less than 3,000 mA SSB/Less than 2,700 mA
Modulation Frequency Response (1 kHz, 0 dB reference)	
Lower at 450 Hz, EIA	: AM — -6 dB SSB — -6 dB
Upper at 2.5 kHz, EIA	: AM — -6 dB SSB — -6 dB
Microphone Sensitivity	
AM : For 50% Mod.	: AM — 1.0 mV
SSB : For 4 Watts PEP	: SSB — 1.0 mV
Microphone Amplifier Circuit Dynamic Range	: AM — 60 dB (between 98% and 80% modulation) SSB — 60 dB (between 12W P.E.P. and 10W P.E.P.)

PUBLIC ADDRESS AMPLIFIER:

Maximum Output Power	: 5 Watts
----------------------	-----------

WARNING: To prevent fire or shock hazard, do not expose this Transceiver to rain or moisture.

C.R.S. LICENCE (AUSTRALIA)

Before transmitting with your transceiver, you must obtain a Postal and Telecommunications Department Citizens Radio Service licence. We have provided such an application form with your unit. Before completing the form you should read the conditions governing the licensing and operation of the Citizens Radio Service (P. and T. Dept. brochure RB14). This brochure can be obtained from the P. and T. Department. After completing the application form, mail it with the appropriate fee to the Superintendent, Regulatory and Licensing in the state or territory in which the station will be operated.

Postal and Telecommunications

Department Approval Number _____

FREQUENCIES AVAILABLE FOR CITIZENS RADIO SERVICE OPERATION

Channel	MHz	Channel	MHz	Channel	MHz
1	27.015	7	27.095	13	27.165
2	27.025	8	27.105	14	27.175
3	27.035	9	27.115	15	27.185
4	27.055	10	27.125	16	27.195
5	27.065	11	27.135	17	27.205
6	27.085	12	27.155	18	27.225

Note: Channel 5 is used for Emergency call.

INSTALLATION

CAUTION: Do not attempt to operate your Transceiver without an Antenna or dummy-load connected to the ANTENNA jack. To do so may damage your Transceiver.

For fixed or base station operation, simply connect the DC power cable to a source of 12 volts DC power and plug into the back of the Transceiver. The only other thing you require is an Antenna connection.

Safety and convenience are the primary considerations for mounting any piece of mobile equipment. All controls must be readily available to the operator without interfering with the movements necessary for safe operation of the vehicle. Be sure all cables are clear of the brake, clutch and accelerator. Also, thought must be given to the convenience of passengers (will they have adequate leg room?).

Another extremely important requirement is the ease of installation and removal (for service and maintenance). Mount the transceiver so it can be slipped in and out very easily.

The most common mounting position for a transceiver of this size is under the dashboard directly over the driveshaft hump. Do not mount the transceiver in the path of the heater or airconditioning air stream. Be sure the chassis of the transceiver is electrically connected to the ground system of the vehicle or boat. Use a separate ground wire to be sure.

When you have determined the best location for mounting, use the Mobile Mounting Bracket as a template to mark mounting holes. Take care when you drill holes that you do not drill into wiring, trim or other accessories. Mount in position with bolts, lockwashers and nuts or self-threading screws.

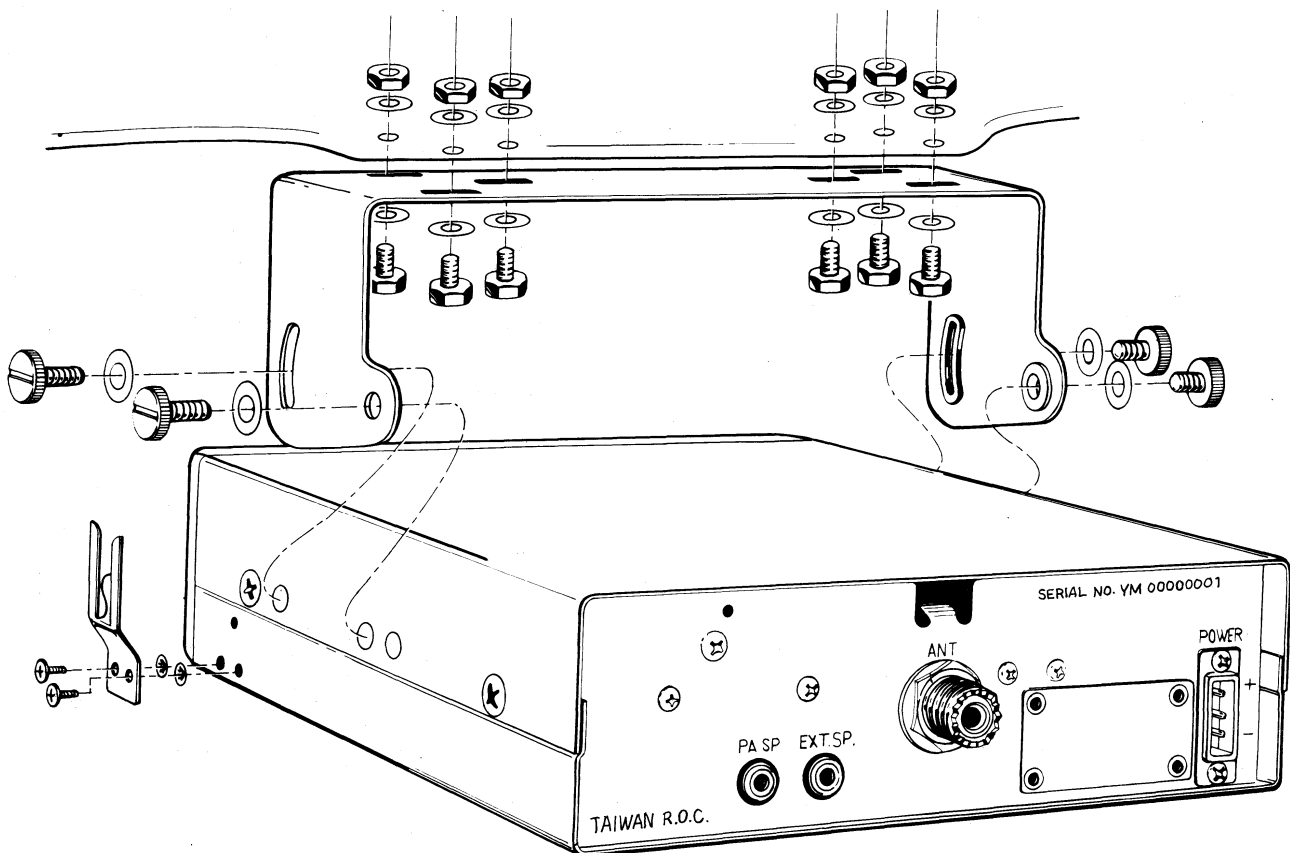

For Negative Ground Electrical Systems: Connect the Red wire (with in-line fuse holder) to the Accessory terminal on the ignition switch of your vehicle. Make a good mechanical and electrical connection to the frame of the vehicle for the black (negative) wire.

For Positive Ground Electrical Systems: Connect the Black wire to the Accessory switch "hot" terminal and connect the Red Wire to the metal frame of the vehicle. Thus, Black always goes to negative (-) and Red always goes to positive (+).

You can use an auto accessory plug (TANDY Catalog No. 274-331) to connect your transceiver to the vehicle's cigarette lighter socket. However, it is better to connect the DC power cord directly to the accessory terminal of the ignition switch. This will prevent unauthorized usage of the transceiver, and will also prevent you from leaving the transceiver on unintentionally.

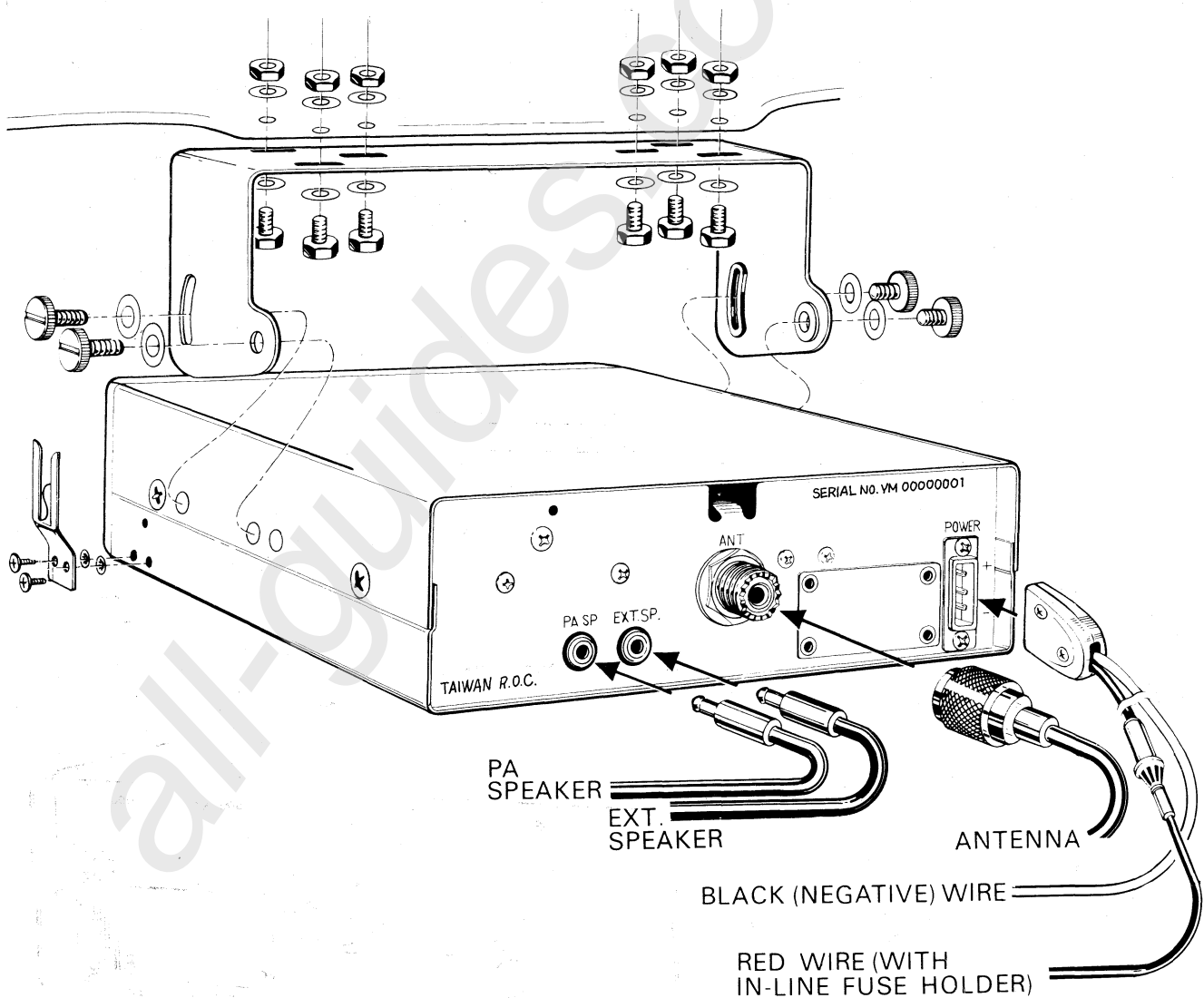

ANTENNA SYSTEM

The antenna system includes the transmission line, and it is very important that you use the correct type of transmission line. The transmission line should be of the coaxial type and should have an impedance equal to the antenna impedance.

Since your Transceiver is designed to operate most efficiently into a 50 ohm load, it is best to use a type of coaxial cable with an impedance of 50 ohms. We suggest type RG-58/U for short lengths and RG-8/U for long lengths.

Generally speaking, you should keep the length of the transmission line to a minimum. Remember that line losses increase with frequency. Use foam-insulation coax for best results.

The above discussion is as important for reception as it is for transmission. If a mismatch exists between the antenna and the receiver, the excellent sensitivity and signal-to-noise ratio of the receiver circuitry will be defeated.

FIXED STATION ANTENNAS

The most popular fixed station antenna is a complex colinear or ground plane.

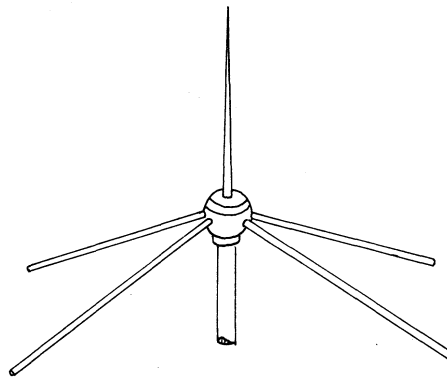

GROUND PLANE

BASE STATION ANTENNA

Your TANDY store carries a complete line of base station CB antennas and accessories. For maximum efficiency, we strongly recommend using an SWR meter to aid in the proper matching between your antenna and Transceiver.

The antenna system should be adequately grounded.

Always use a lightning arrester for your antenna system.

MOBILE STATION ANTENNAS

Mobile CB antennas are one of two types, a full-length or a loaded whip. Your TANDY store carries a complete line of both types of mobile antennas.

The location of the antenna has a great effect on the antenna efficiency and directivity. Antennas mounted in the center of the roof radiate equally in all directions. A bumper mounted antenna radiates in a pattern directly in front of and to the rear of the vehicle, with maximum radiation directly away from the vehicle, in a horizontal plane.

Since the normal $\frac{1}{4}$ wavelength whip antenna is too long (2.6m) for roof mounting on a vehicle, the antenna is shortened and a loading coil is utilized to provide the proper electrical length. As a result, the overall efficiency is reduced and the nondirectional advantage is defeated. Thus, a bumper mounted full-length whip antenna will normally give the best results.

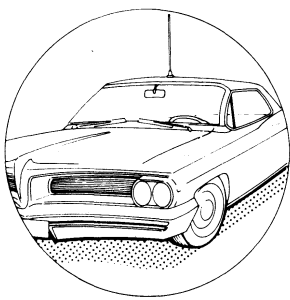

ROOF MOUNT

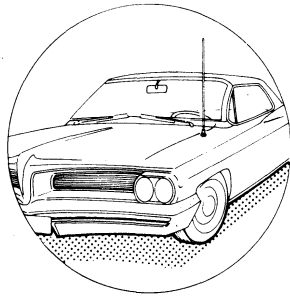

FRONT COWL MOUNT

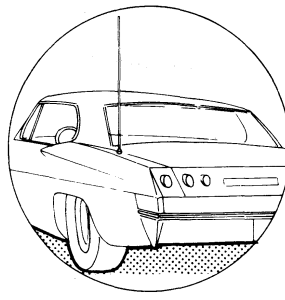

REAR DECK MOUNT

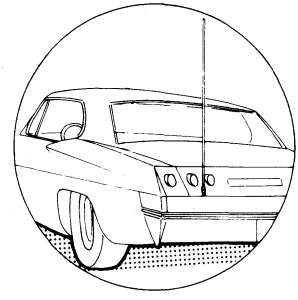

BUMPER MOUNT

A few general rules should be followed for proper installation of any mobile antenna:

1. Keep it as far as possible from the main bulk of the vehicle.
2. Keep as much of it as possible above the highest point of the vehicle or boat.
3. During operation, it must be vertical. Thus, it should be mechanically rigid so it will maintain a vertical position when the vehicle or boat is in motion.
4. Mount it as far as possible from sources of noise (ignition system, gauges, etc.) and convenient for transmission line routing away from these noise sources.

An antenna mounted in a boat requires a ground. This can be either the metal hull or a ground made of tin-foil or copper sheeting. This ground should cover an area of 1 m² or more. Be sure the transceiver has an adequate ground as well. If you use TANDY's 2.6 m Fiberglass Marine Antenna (21-912), you won't need a ground; it has been designed with its own "ground" system.

NOISE

Your vehicle or boat can be the cause of much noise interference. Your TRC-449 incorporates a built-in Automatic Noise Limiter circuit for AM, plus a Noise Blanker for both AM and SSB reception. Also, it has built-in power supply filtering. These circuits can help to reduce and/or eliminate annoying noise.

Remember, your transceiver has a very sensitive receiver and it will pick up even the smallest trace of ignition noise. Any noise that you hear in the transceiver is almost totally from external sources. The receiver itself is exceptionally quiet. Steady high noise levels can not be eliminated by the internal Automatic Noise Limiter and Noise Blanker circuits. Noise problems can not be solved internally (in the transceiver); they must be solved at the source of the noise.

If you wonder if the noise is from your ignition system, the transceiver or an external source, try this simple test. Turn your ignition switch off and set it to ACC (accessories). This turns off the ignition, but supplies power to the transceiver. Most of the noise will disappear—indicating that the source of noise is your ignition system.

This interfering noise can be generated anywhere in the electrical system of the vehicle or boat. The first step in reducing or eliminating this noise is to locate the source of the noise.

IGNITION SYSTEM

The most common source of noise is the ignition system. This noise can be identified by the fact that, it varies with the speed of the engine. It consists of a series of popping sounds occurring at a regular rate that will vary with the speed of the engine and stop when the ignition is turned off.

There are a number of things that can be done to reduce this type of noise:

1. Use only the "radio suppression type" high voltage ignition wire. Most new cars come already equipped with this type of wire.
2. Inspect the high voltage ignition wire and all connections made with this wire. Old ignition wire may develop leakage, resulting in hash.
3. If noise still persists, replace the spark plugs with spark plugs that have suppressor resistors built-in. Be sure to use the correct type for your vehicle.

Other sources of noise are: generator/alternator, regulator, gauges and static discharge. Most of these types of noise can be effectively reduced or eliminated by using bypass capacitors at the various output voltage points. Once again, we suggest you check your TANDY store for a wide selection of noise reduction accessories.

CONTROLS AND THEIR FUNCTIONS

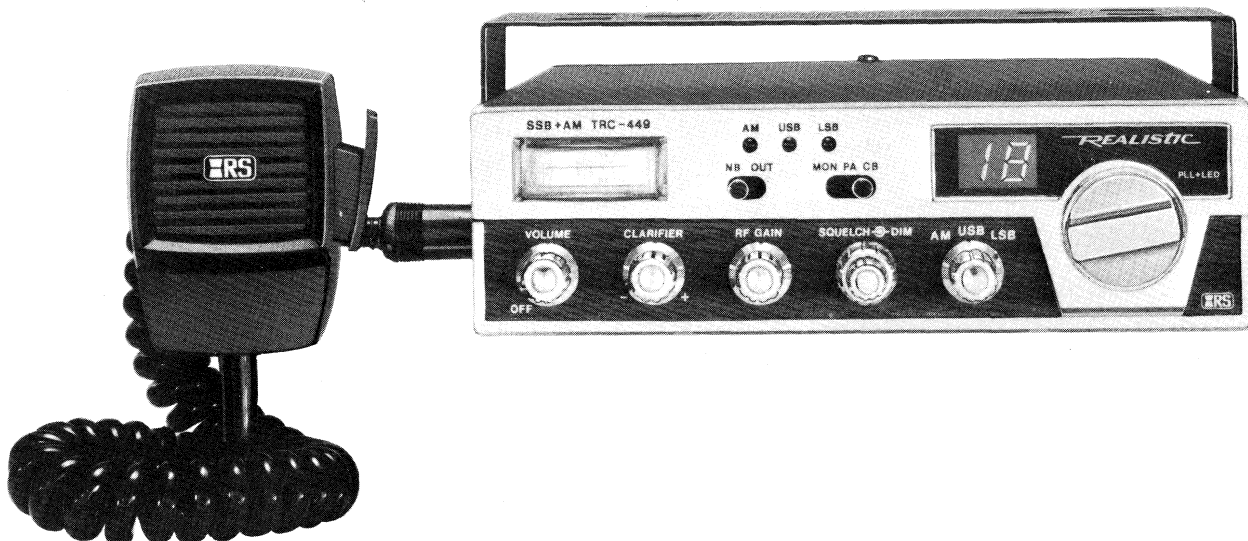

This short description of the function of each control and jack supplies background information for proper operation. For actual Operating Instructions, refer to **Using Your Transceiver**.

MICrophone (on the side) . . . The dynamic microphone must be connected to this jack. To Transmit, press the button on the mic and talk into the mic. To Receive, release the button.

When transmitting, hold the microphone at an angle, 5–7.5 cm from your mouth and speak clearly in a normal voice.

VOLUME with "ON/OFF" Switch . . . Turn clockwise to apply power to the unit and then adjust for the desired level of sound from the speaker. When using PA it controls the level of the PA output.

CLARIFIER . . . Functions as a "fine tuning" (or "delta" tuning) for reception of Single Sideband and AM signals when the Mode switch is set to either **LSB** or **USB**. This permits you to tune your receiver to exactly the same frequency of any other station or stations which you are communicating with.

RF GAIN . . . varies the sensitivity of the **RF** amplifier stages of the Receiver circuitry. For normal operation, set **RF GAIN** to maximum and adjust **VOLUME** for a suitable listening level. Under high-signal conditions, you may want to turn **RF GAIN** down a little and raise **VOLUME** as required.

SQUELCH . . . Sets the level of the internal Squelch circuitry to cut out the background noise when no signal is being received. When properly set, it allows signals to come through, but cuts off the receiver sound when no signal is being received, thus eliminating annoying background/atmospheric noise during standby and monitoring conditions.

If set too high, you may miss some of the weaker signals. Operating conditions will determine the best setting.

DIM . . . Controls the brightness of the Channel indicator LED. Turn clockwise to make brighter.

AM-USB-LSB Mode Switch . . . set this switch to the desired mode of operation for both transmit and receive. When in the **AM** position, both transmitter and receiver sections are operative for **AM**. When set to the **LSB** position, the Receiver operates to receive only the lower sideband portion of a signal; the Transmitter will transmit only the lower sideband of the modulated waveform. In the **USB** position, the Receiver operates only to receive the upper sideband portion of a signal; the Transmitter will transmit only the upper sideband of the modulated waveform.

Channel Selector . . . use to select any one of the standard 18 CB channels.

MON-PA-CB Switch . . . Controls the function of the audio amplifier/modulation circuitry when the Microphone button is pressed. When the slide switch is in the "CB" position, the Microphone button turns the Transmitter on for normal transmissions. When set to 'PA' position, the Transmitter will not function -- the Microphone turns on the Public Address Amplifier function. For PA operation you must have a PA speaker connected to the PA jack on the rear chassis. When set to 'MON' position, you can use the PA function and yet can monitor CB incoming signals.

NB slide Switch (Noise Blanker) . . . Set to NB to cut out annoying impulse-type noise. Set to OUT to release this function. This is particularly effective for ignition noise on both AM and SSB.

RF-S Meter . . . give visual indication of signal strengths. When receiving, the RF-S Meter shows the strength of incoming signals; a change of one "S" unit indicates a change of 6 dB in signal strength. The meter is set up so that a 100 microvolt signal will produce a reading of S-9. When Transmitting, the RF-S meter gives a relative indication of output power from the Transmitter.

THE REAR PANEL

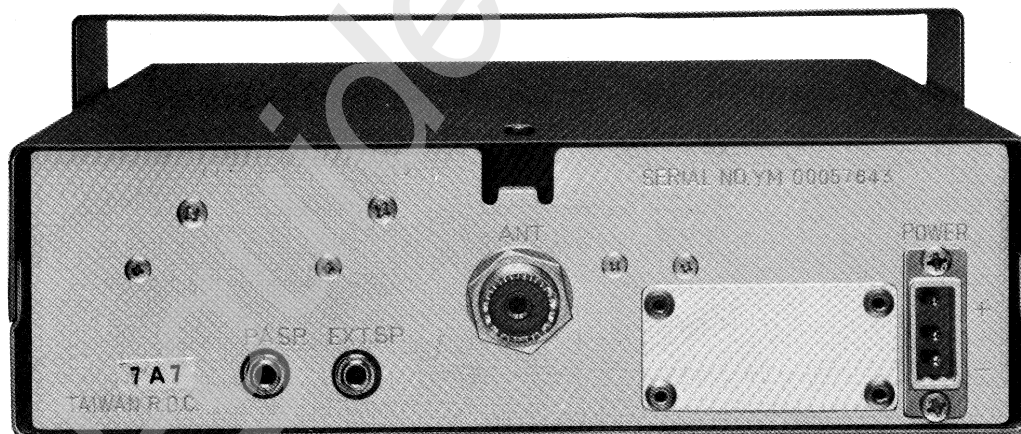

PA SPeaker Jack . . . connect an 8-ohm Public Address speaker to this jack for PA use. We recommend TANDY 40-1244, weatherized, rugged PA Speaker, as an ideal unit for either PA or External Speaker application.

EXTeRnal SPeaker Jack . . . if you want to use an external speaker, plug it into this jack. You should use a standard 8 ohm type. When an external speaker connected to this jack, the built-in speaker is automatically disconnected.

ANTENNA Coax Connector . . . connect your CB antenna to this (SO-239 type, accepts PL-259 connectors).

12V DC connector and Power Cable with in-line fuse . . . this cable is to be connected to a source of 12-16 volts DC power, negative or positive ground. The Red wire with the in-line fuse must be connected to the + side and the Black wire to the - side.

10-CODES

Citizen band radio operators have largely adopted the 10-code for standard questions and answers. Its use permits faster communication and better intelligibility in noisy areas. The following table lists some of the more common codes and their meanings.

Code	Meaning	Code	Meaning
10-1	Receiving poorly	10-10	Standing by
10-2	Receiving well	10-13	Advise road/weather conditions
10-3	Stop Transmitting	10-20	What is your location?
10-4	OK	10-33	Emergency traffic
10-7	Out of Service	10-36	Correct time
10-8	In Service	10-41	Switch to Channel
10-9	Repeat	10-62	Cannot copy you

USING YOUR TRANSCEIVER

Note: For detailed information on Installing, refer to INSTALLATION. Do not transmit without an Antenna or suitable load connected. Do not operate the PA function without a speaker connected to the PA SP jack.

Your Transceiver can be used either as a base or mobile unit.

Connect the power cable to a source of 12 volts DC.

Connect coaxial transmission cable from your Antenna to the **ANTENNA** coax connector on the rear panel.

For most efficient operation and safety, use a separate ground wire connection between the chassis of your Transceiver and a cold water pipe or ground rod.

TO RECEIVE AM SIGNALS

1. Set **RF GAIN** control maximum clockwise.
2. Set **SQUELCH** control maximum counterclockwise.
3. Set Mode to **AM**.
4. Turn power "on" by rotating **VOLUME** clockwise.
5. Set **Channel Selector** to the desired channel.
6. Adjust **SQUELCH** to cut out annoying background noise when no signal is being received. To do this, set **Channel Selector** to a channel where no signals are present (or wait till signals cease on your channel). Then, rotate **SQUELCH** in a clockwise direction to the point where the background noise just stops. Now, when a signal is present, you will hear it, but will not be disturbed by noise on the channel in between signals.

When properly set, **SQUELCH** will keep the receiver "dead" until a signal comes in on that channel. Do not set **SQUELCH** too high, or weak signals will not be able to "open" the Squelch circuit. To receive weak signals, it is best to leave **SQUELCH** set to the minimum position (maximum counterclockwise).

7. Use **CLARIFIER** to tune in slightly off-frequency stations, or to tune out adjacent channel interference caused by a station on the next channel (which may be too close to your channel).
8. Adjust **VOLUME** for a suitable listening level.

If your reception is disturbed by interference from impulse-type noise (ignition noise and other man-made electrical noise), set **NB** switch to 'NB' position. The Noise Blanker circuitry is most effective with impulse noise.

If you want to vary the brightness of the Channel indicator LED, adjust **DIM** control.

Often you'll find an external/remote speaker will be most advantageous. We've made provisions for connecting such a speaker — just connect it to the EXT SP jack on the back. TANDY sells a number of fine speakers for this purpose — we recommend Catalog Number 21-549. When you connect a speaker to this jack it automatically disconnects the internal speaker.



21 – 549

TO RECEIVE SSB OR DSB SIGNALS

1. Set **RF Gain** maximum clockwise.
2. Set **SQUELCH** maximum counterclockwise.
3. Set Mode to either **LSB** (lower sideband) or **USB** (upper sideband), depending on which sideband is being used by the transmitting station.

NOTE: When receiving DSB (double sideband) signals, you can use either **LSB** or **USB**.

4. Turn power "on" by rotating **VOLUME** clockwise.
5. Set **Channel Selector** to the desired channel.
6. Adjust **SQUELCH** as noted above.
7. Use **CLARIFIER** to tune in the SSB signal.
SSB tuning takes practice; it is not difficult, it just takes a little experience. When first listening to an SSB signal, it probably will not be understandable; the voice may sound like "Donald Duck", or just a low guttural sound. In either case, very slowly adjust **CLARIFIER** to bring the signal into its natural voice tonal range.

If the signal is Donald Duck type, tune so the signal tones become lower in tone; careful tuning will make the voice sound natural. If the signal is low and guttural, tune for higher tones.

NOTE: If you try the above procedure and are not able to make the signal intelligible, it may be an SSB signal operating on the other sideband—try the other SSB Mode (**LSB** or **USB** as the case may be).

8. Adjust **VOLUME** for a suitable listening level.

Use Noise Blanker (**NB**) to reduce or eliminate noise interference. Use the position which results in greatest noise reduction.

Notes on Receiving

An SSB signal will produce a fluttering, unintelligible sound when receiving in the **AM** mode; in such a case, use either the **LSB** or **USB** mode and adjust **CLARIFIER** for intelligibility.

You can tune AM signals when the Mode switch is in the **USB** or **LSB** position; tune **CLARIFIER** control to eliminate the steady tone caused by the AM carrier ("zero-beat" the tone so it disappears).

Remember that adjustment of **CLARIFIER** only shifts the Receiving frequency, **not** the Transmitting frequency.

When receiving an extremely strong SSB signal, you will find it best to use the **RF GAIN** control to vary the volume (rather than using **VOLUME**).

TRANSMITTER OPERATION

1. Be sure **MON-PA-CB** switch is in "CB" position.
2. Plug the Microphone into the **MIC**rophone jack.
3. Set Mode Switch to the desired position.
4. Select the desired channel of operation.
5. Press the push-to-talk button on the side of the Microphone and speak in a normal voice into the Microphone. Best results will be obtained when you hold the mic 2.5-10 cm from your mouth and turned at about a 45° angle (not straight on).
6. When transmitting, the meters will turn red. The RF-S Meter will indicate the relative level of output power.
7. To receive, release the push-to-talk button.



USING THE PUBLIC ADDRESS AMPLIFIER FEATURE



You can use your Transceiver to provide 4-6 watts of audio power as a Public Address amplifier. To use this function, you must connect an 8 ohm public address type speaker to the **PA S**peaker jack on the rear of this unit. We recommend **TANDY 40-1244**; it's a weatherized 10 cm speaker, specifically made for PA use.

1. Be sure an 8 ohm speaker is connected to the **PA S**peaker jack.
2. Set **MON-PA-CB** switch to PA position.
3. Turn the Transceiver "on" with the **VOLUME** control.
4. Connect the microphone and press the push-to-talk button and talk into the mic. Adjust **VOLUME** as required for the appropriate level of sound.
5. Even though you have your Transceiver set for PA operation, you can still monitor CB signals – set **MON-PA-CB** switch to **MON**itor position and CB signals will be heard through the PA speaker. This way you won't miss any important calls, even while using PA. To defeat the receiver sound, set **MON-PA-CB** switch to PA position.
6. To return to normal Transceiver operation, set **MON-PA-CB** switch to CB position.

SSB (SINGLE SIDEBAND) WHAT IS IT?

We thought you'd be interested in knowing and understanding something about the SSB function and capability of your Transceiver.

To understand SSB, we need to know what an AM (Amplitude Modulated) signal is.

Amplitude Modulation is a form of heterodyning—mixing 2 signals together electrically. In the process of mixing, 3 signals result. Example.

An R.F. signal at 27.015 MHz (channel 1 C.B.) is mixed with (modulated by) a 1000 Hz tone.

The resulting signals —

27.015 MHz = original or "carrier" signal

27.015 MHz – 1000 Hz (27,015,000 minus 1000) = 27.014 MHz, the Lower Sideband

27.015 MHz + 1000 Hz (27,015,000 plus 1000) = 27.016 MHz, the Upper Sideband

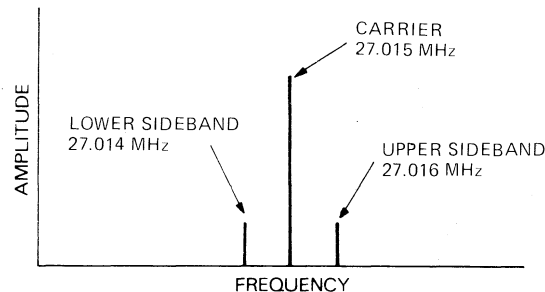

Notice that the communication or intelligence (the 1000Hz tone) is contained in **each** sideband. The Carrier contains no intelligence. This fact is vital!

For the sake of communication, all we need to receive is the 1000 Hz tone. The receiver only needs to recover one signal, and yet we are transmitting 3 signals. Not only are we sending 3 signals, but also we are wasting most of our power in one of them (which carries none of the intelligence, i.e. the carrier, 27.015 MHz) and the other two signals duplicate each other!

Thus, if we can eliminate the carrier (not needed for communication) and can send only one of the sidebands (since they duplicate each other's information anyway), we could concentrate all of the transmitting power into one sideband. This is exactly what Single Sideband accomplishes.

Single Sideband transmissions incorporate only **one** of the sidebands—i.e. in the example above, **only** the upper sideband at 27.016 MHz or **only** the lower sideband at 27.014 MHz. The second sideband and the carrier are eliminated in the early stages of the transmitter circuitry.

SSB LOWER SIDEBAND

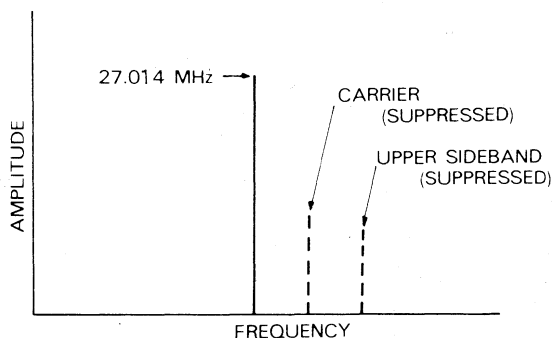

SSB UPPER SIDEBAND

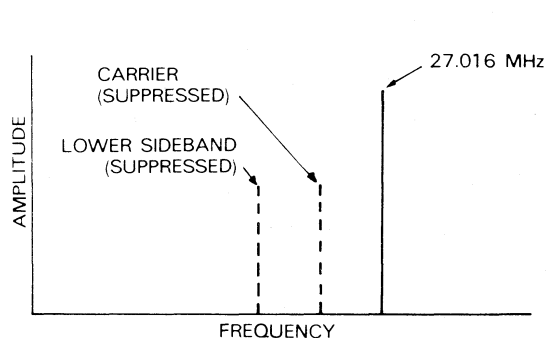

When only one sideband is transmitted, we can concentrate all of the available power in this one sideband, greatly increasing the effective power of an SSB signal as compared to an AM signal.

See Advantages of SSB Over Normal AM.

ADVANTAGES OF SSB OVER NORMAL AM

A theoretically perfect AM transmitter used in Citizens Band Radio Service as permitted by the PMG will have the following maximum output power specification:

Carrier --- 4 watts with the capability of slightly less than 100% modulation

In order to fully Amplitude Modulate a 4 watt carrier, a full 2 watts of audio power is required. In this case, only 1 watt of power can exist in each sideband. Since the carrier contains no intelligence, and the sidebands duplicate each other, really only one sideband is required to transmit the required intelligence.

If we take the above transmitter and convert it to Double Sideband operation (eliminate the carrier power), we can increase the power in the sidebands to 2 watts each, without overloading the circuitry. Further, if we eliminate one of the two sidebands, we can put the full 4 watts of power into remaining sideband. Thus, while an AM transmitter has only 1 watt of power in one sideband, an SSB transmitter can have 4 watts of power in one sideband—or **4 times the power of an AM transmitter**.

Thus, effectively an SSB transmitter with the same power limitations is 4 times more powerful than an AM transmitter.

One further advantage, which is not often mentioned. Not only does the SSB signal take up only 1/2 of the frequency spectrum space of an AM signal (only 1 sideband instead of 2), thus permitting twice the number of stations to be in the same amount of band space—but also, at the receiving end, the receiver only picks up 1/2 of the total AM bandwidth. This means that 50% less noise is amplified along with the signal. This results in a 50% improvement in signal-to-noise figures; or, in more technical terms, a 3 dB improvement.

Thus, given equal limitations and conditions, an SSB signal will be 4 times more powerful and will have 2 times the signal-to-noise advantage of an AM signal—**8 times as effective**. In technical terms, a 9 dB advantage. Thus, for an AM transmitter to be equivalent in effectiveness it would have to be rated at 32 watts!

Enough said! We hope you're enthused.

MAINTENANCE

Since only the finest quality parts are used throughout your Transceiver (and these are all conservatively rated), you will need little or no service or repair of the unit.

Be sure you treat it with the care deserving of such a piece of electronic equipment. It is rugged and designed for either base or mobile use—but do not abuse it. Be sure you always make proper connections and adequate mounting provisions.

If you run into problems with the unit, we recommend you check the following:

1. If trouble is experienced with receiving.
 - Check the **VOLUME** On/Off switch setting.
 - Be sure **SQUELCH** is adjusted properly. Is it over-squelched?
 - Check if the unit is switched to an operating channel.
2. If trouble is experienced with transmitting.
 - Check if the transmission line is securely connected to the ANTenna Connector.
 - Check to be sure the antenna is OK.
 - Are all transmission line connections secure and free of corrosion?
 - Make sure you are fully depressing the Push-To-Talk Button on the Mic.
 - Be sure Mic connector is firmly pressed into its jack.
3. If the transceiver is completely inoperative.
 - Check the power cable and in line fuse (3A).

If these checks don't solve the trouble, do **NOT** attempt repairs or adjustments yourself. The unit should be serviced only by a qualified radio technician. Whenever possible, return the unit to the store from which it was purchased.

WARNING

Do not open up the Transceiver to make any internal adjustments. Internal adjustments and/or modifications can lead to illegal operation as defined by PMG, Rules and regulations. Such illegal operation can lead to very serious consequences.

BLOCK DIAGRAM

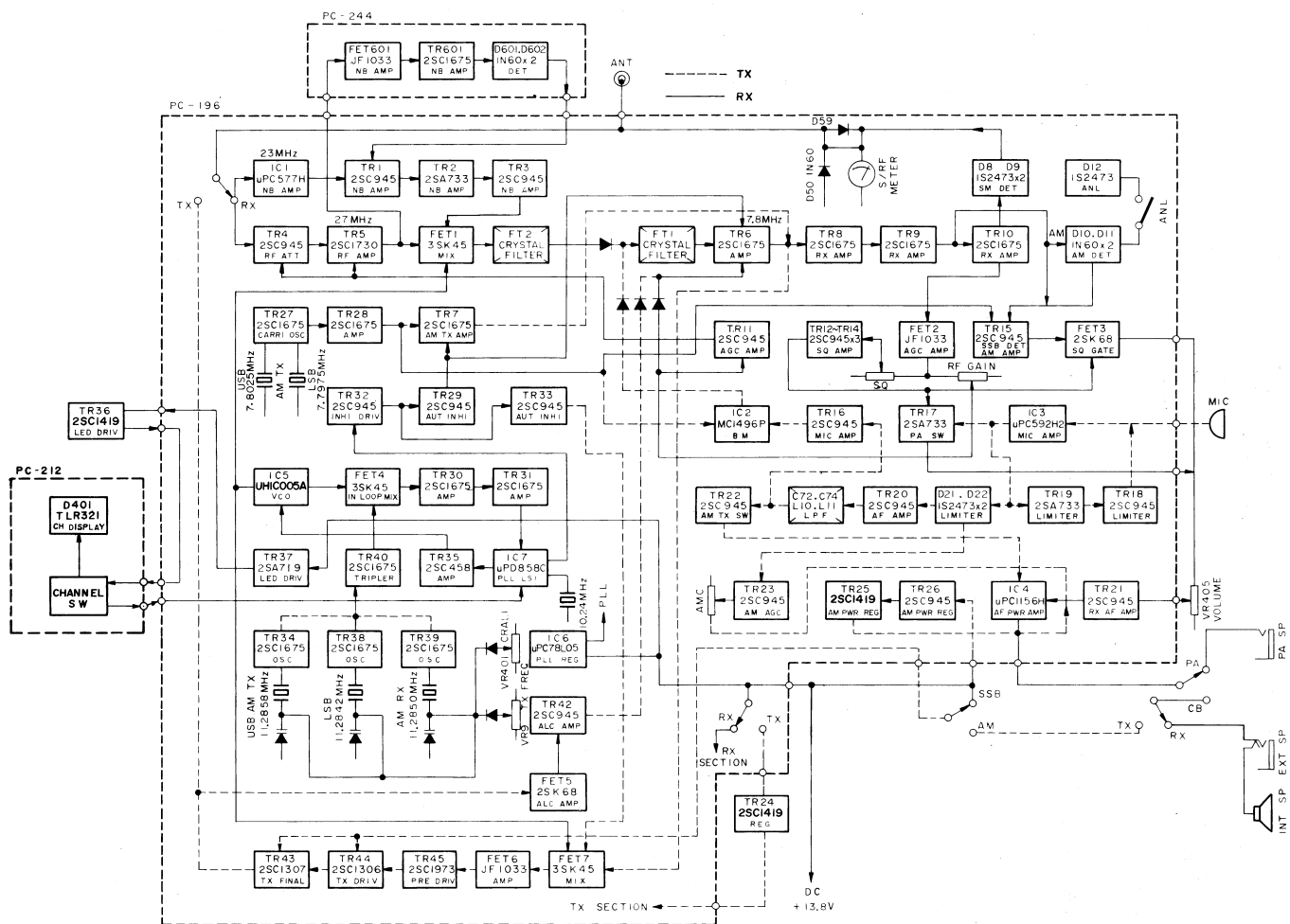

SCHEMATIC DIAGRAM

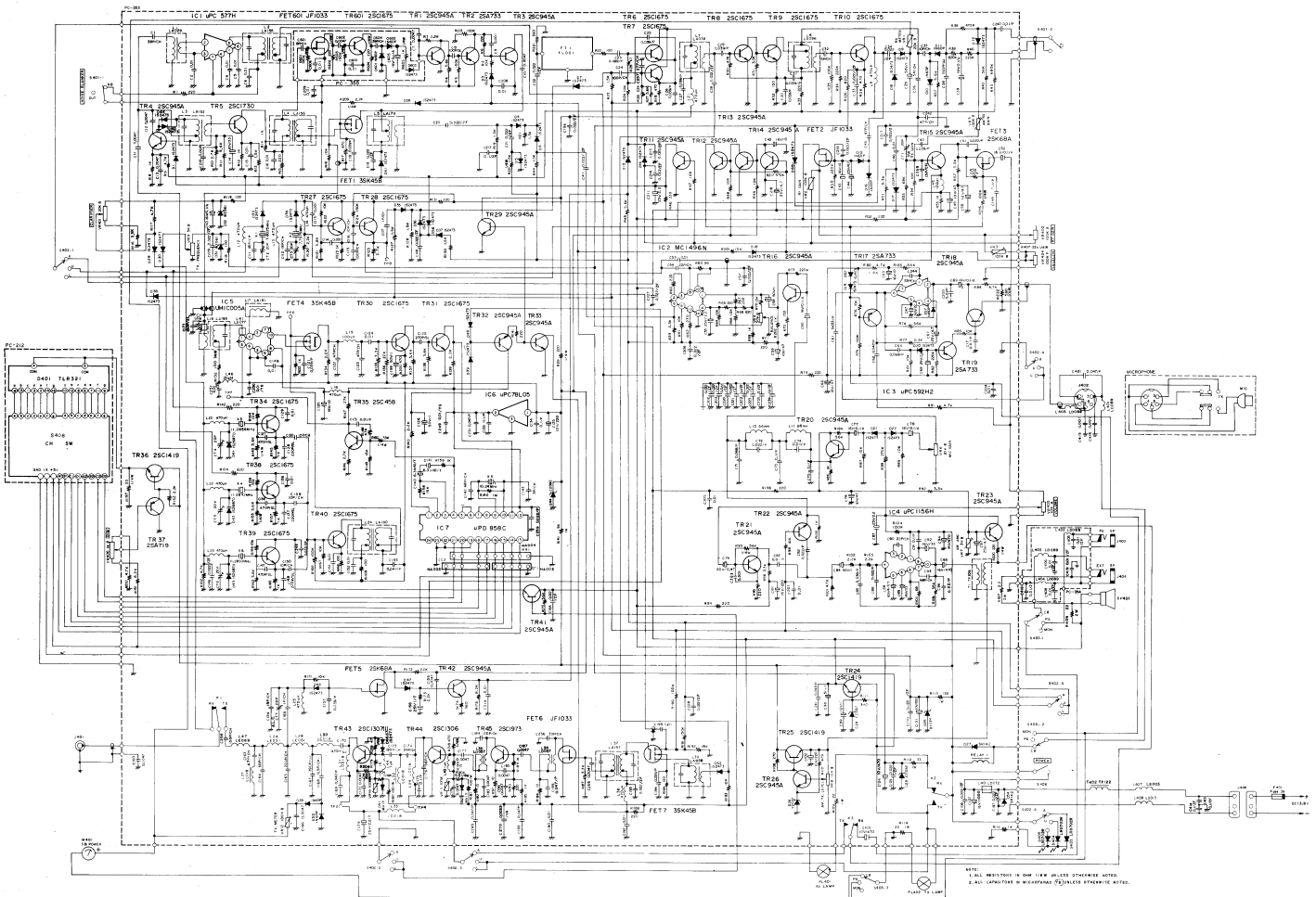

TANDY LIMITED WARRANTY

This equipment is warranted against defects for 90 days from date of purchase. Within this period, we will repair it without charge for parts and labor. Simply **bring your sales slip** as proof of purchase date to any TANDY store. Warranty does not cover transportation costs. Nor does it cover equipment subjected to misuse or accidental damage.

We Service What We Sell

**For service, return this set to your nearest
TANDY ELECTRONICS store.**

**Head Office:
TANDY CORPORATION
280-316 VICTORIA ROAD
RYDALMERE, N.S.W. 2116**

TANDY CORPORATION

AUSTRALIA

280-316 VICTORIA ROAD
RYDALMERE, N.S.W. 2116

BELGIUM

PARC INDUSTRIEL DE NANINNE
5140 NANINNE

U. K.

BILSTON ROAD, WEDNESBURY
WEST MIDLANDS WS10 7JN